

CMUN-1000CC/10-UA4-F

Capacitor Specifications

Capacitance C_{max} (nominal)	1000 pF
Capacitance C_{min} (nominal)	100 pF
Voltage (Peak Test U_{pt} / Peak Working U_{pw})	10 kV / 6 kV
Ground to variable end insulation (Peak Test)	10 kV
Capacitance Tolerance (linear Range)	1%
Max. Current I_{max} at 13.56 MHz with	91 Arms
Conduction Cooling	20 W
Self Inductance	≤ 9 nH
Capacitance per 100 steps	22.4 pF
Net Weight	1.25 kg
Ground to variable end capacitance	≤ 5 pF

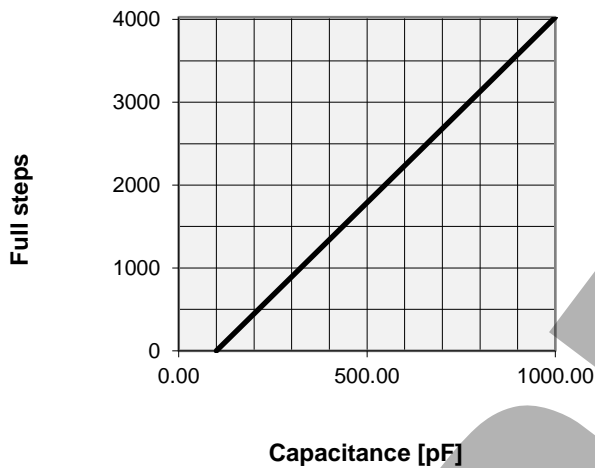

I_{max} at 25°C ambient and 125°C surface temp. for convection and conduction (20 W) cooling

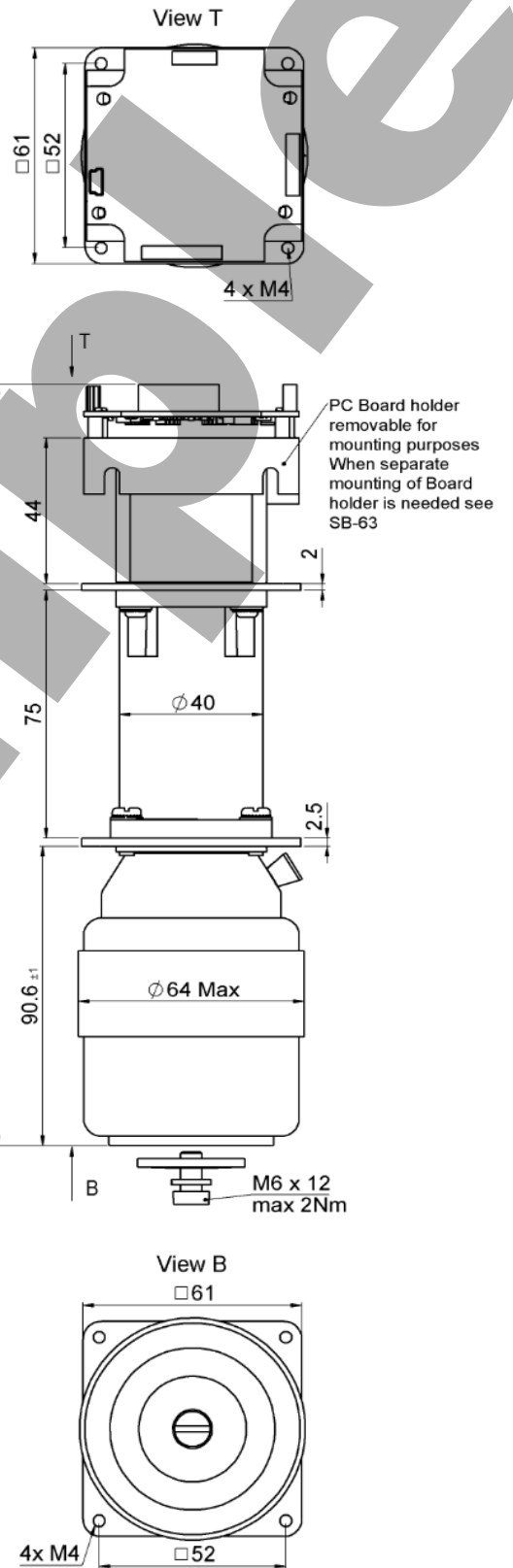
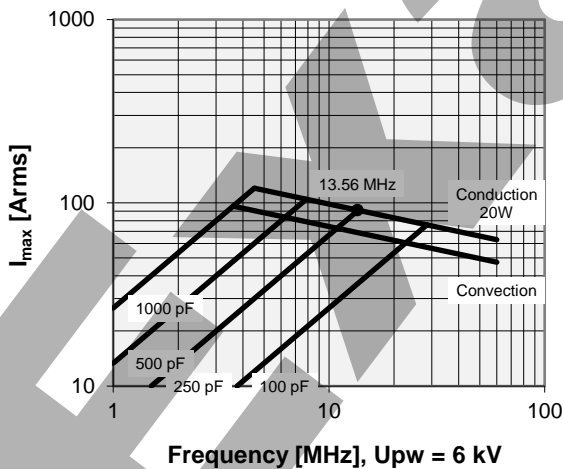

Note:
 Technical information in Service Bulletin
 SB-52 and SB-60 must be considered
 Subject to change without prior notice

Issue: 18-Dec-2018
 Replaces: 31-May-2018
 pct.comet.tech

CMUN-1000CC/10-UA4-F

Full steps	Nominal Capacitance [pF]	Tolerance
0	100.0	+/- 1pF
800	279.0	1%
1600	458.0	1%
2400	637.0	1%
3200	816.0	1%
4026	1000.0	1%

Lower factory Limit: 100pF
Upper factory Limit: 1000pF

Self inductance and resonance frequency

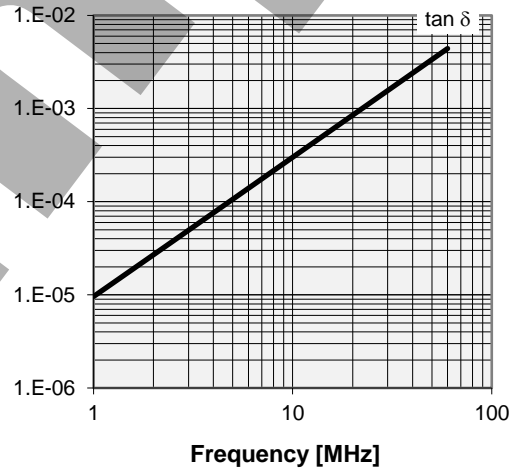
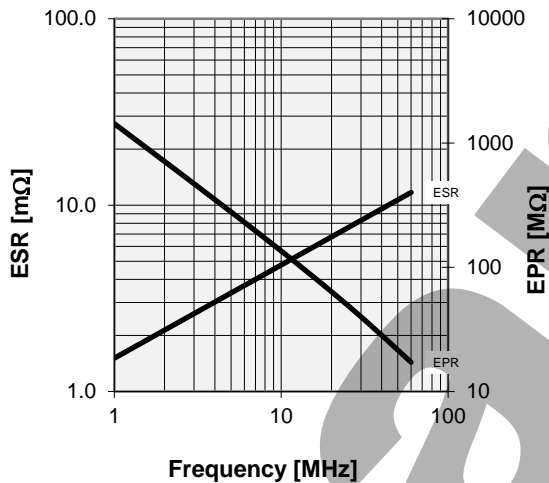
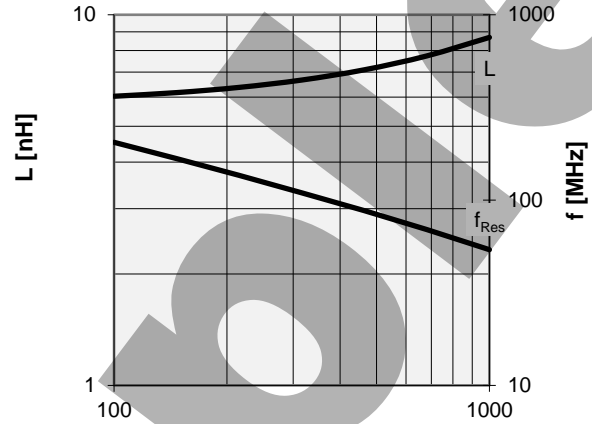

Special Features:
Firmware: 20108308, RoHS Compliant

General handling information for the integrated drive
When installing or removing the integrated drive, extreme care must be taken to avoid damage to the body of the integrated drive. Although the integrated drive look very rugged from the outside it must be remembered that, due to the brazing process used to join ceramic and copper, the copper is in a soft, annealed condition and is therefore highly susceptible to mechanical deformation. For this reason, any rough handling, like machining of the flanges, must be avoided. Use existing threads and holes for fixation.

General installation information for the integrated drive
For all integrated drives we recommend that one side be mounted non-rigid to prevent excessive thermomechanical and external forces from acting on the capacitor.

Note:
Technical information in Service Bulletin
SB-52 and SB-60 must be considered
Subject to change without prior notice

CMUN-1000CC/10-UA4-F

Drive Specification	
Interface	RS232, RS485
Tuning speed (end to end)	3 s
Backlash	≤ 2 steps
Operation mode	Unipolar
Nr. of phases	2
Current per phase	1.2A (limited)
Supply voltage (DC)	24 VDC
Full step angle	1.8°
Motor frame size	42 mm

Connector: Motor	
Pin 1	OA1
Pin 2	OA2
Pin 3	OB1
Pin 4	OB2

Connector: VCC / Interfaces	
Pin 1	GND
Pin 2	VCC: +24V DC nominal (10... 30V DC)
Pin 3	RS485 (A+)
Pin 4	RS485 (B-)
Pin 5	RS232 (TX)
Pin 6	RS232 (RX)

Layout of the microcontroller PCB

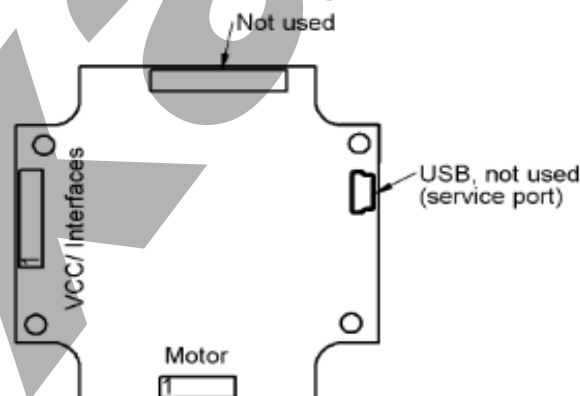

Note:

Technical information in Service Bulletin SB-52 and SB-60 must be considered
Subject to change without prior notice